

Please read and save this Repair Parts Manual. Read this manual and the General Operating Instructions carefully before attempting to assemble, install, operate or maintain the product described. Protect yourself and others by observing all safety information. The Safety Instructions are contained in the General Operating Instructions. Failure to comply with the safety instructions accompanying this product could result in personal injury and/or property damage! Retain instructions for future reference. AMT reserves the right to discontinue any model or change specifications at any time without incurring any obligation.

©2015 AMT Pump Company, A Subsidiary of The Gorman-Rupp Company, All Rights Reserved.

Periodic maintenance and inspection is required on all pumps to ensure proper operation. Unit must be clear of debris and sediment. Inspect for leaks and loose bolts. Failure to do so voids warranty.

Self-Priming Centrifugal Pumps

High Volume Dewatering Cast Iron Models



Refer to pump manual 1808-634-00 for General Operating and Safety Instructions.

DESCRIPTION

These centrifugal pumps are self-priming (to 20 ft. lift) units designed for high volume liquid transfer, irrigation, dewatering, lawn sprinkling, etc. These pumps can also accommodate semi-solids (up to 3/8" dia.), sediment laden liquids, and liquids with entrained air or gases. Units are constructed of cast iron and include Buna elastomers (Viton® elastomers optional, contact factory for availability). They are direct coupled to NEMA 56J frame, 3450 RPM motors which require field wiring, no controls are supplied. Each pump is equipped with a flapper valve to shorten re-prime time after initially filling casing with liquid. Handles liquids from 40° to 180° F (4° to 82° C). For use with nonflammable, non-abrasive liquids compatible with pump component materials.

MAINTENANCE

▲ WARNING

Make certain that unit is disconnected from power source before attempting to service or remove any components!

NOTE: The pump casing should be removed and inspected periodically to ensure that any foreign material is not clogging internal pump parts. This unit is equipped with a dual volute pump casing. One of the volutes runs 180°, all the way from the side opposite the discharge into the discharge through a completely enclosed passageway. If foreign material clogs this area, it can be dislodged by using a wire or long spring.

MECHANICAL SEAL REPLACEMENT

Refer to Figures 1 and 2

IMPORTANT: Always replace both seal seat (Ref. No. 7) and seal head (Ref. No. 8) to ensure proper mating of components! Recommend replacing casing seal (Ref. No.6) if wear or damage is present.

1. Unthread fasteners (Ref. No. 5) and remove casing (Ref. No. 12) and casing seal (Ref. No. 6) from adapter (Ref. No. 4)
2. Unscrew impeller fastener (Ref. No. 11) and impeller (Ref. No. 10) separately by turning each counterclockwise.

NOTE: Most motors use an open end 7/16" wrench across flats on rear of motor shaft (remove bearing cap for access) to prevent shaft from turning. Other motor shafts have a screwdriver slot instead of flats.

3. Unscrew fasteners (Ref. Nos. 3 & 16) and remove adapter, foot (Ref. No. 17) and handle (Ref. No. 2) from motor (Ref. No. 1) mounting face. Seal head will come loose at this time.
4. Push seal seat from adapter recess with a screwdriver.
5. Clean adapter recess before inserting new seal seat.
6. Carefully wipe polished surface of new seal seat with a clean cloth.
7. Wet rubber portion of seal seat with a light coating of soapy water.
8. Press new seal seat squarely into cavity in adapter. If seal seat does not press squarely into cavity, it can be adjusted in place by pushing on it with a piece of pipe. Always use a piece of cardboard between pipe and seal seat to avoid scratching seal seat. (This is a lapped surface and must be handled very carefully.)

9. After seal seat is in place, ensure that it is clean and has not been marred.
10. Using a clean cloth, wipe shaft and make certain that it is perfectly clean.
11. Secure adapter, foot and handle on motor mounting face. Carefully guide motor shaft through seal seat.
12. Apply a light coating of soapy water to inside rubber portion of seal head and slide onto shaft (with sealing face first) so that rubber portion is just up over shaft shoulder.

▲ CAUTION

Do not touch or wipe polished face of seal head.

13. Replace any impeller shims (Ref. No. 9) that may have been removed in disassembly. (See "Shim Adjustment" below).
14. Screw impeller back into place, tightening until it is against shaft shoulder.
15. Replace impeller nut and tighten until snug.
16. Remount casing and casing seal on adapter.

SHIM ADJUSTMENT

When installing a replacement impeller (Ref. No. 10) or motor (Ref. No. 1), it may be necessary to adjust number of shims (Ref. No. 9) to ensure proper running clearance between impeller and casing. Proceed as follows:

NOTE: A proper running clearance is less than 0.010".

1. For impeller replacement, add one 0.010" shim in addition to those removed originally.
2. For motor replacement, add two 0.010" shims in addition to those removed during disassembly.
3. Reassemble the pump as described in steps 15, 16 & 17.

IMPORTANT: Be sure that the casing is snugly in place and check shaft to make sure it is turning freely (use screwdriver slot in motor to turn shaft). If it turns freely, check to ensure that adapter and casing are fitted tight together. If they are not, tighten fasteners (Ref. Nos. 3, 5 and 17) and recheck shaft for free turning. Tighten carefully, turning shaft while tightening so that motor bearings are not damaged in the event that too many shims were installed. If shaft seizes before fasteners are completely tight, disassemble pump and remove one shim and repeat reassembly.

Self-Priming Centrifugal Pumps

FLAPPER VALVE ASSEMBLY REPLACEMENT

Remove bolts (Ref. No. 19) and suction plate (Ref. No. 15). Replace flapper valve assembly (Ref. No. 14). Remount suction plate and bolts; tighten bolts evenly to ensure proper seal.

Self-Priming Centrifugal Pumps

For Repair Parts contact dealer where pump was purchased.

Please provide following information:

-Model Number

-Serial Number (if any)

Part description and number as shown in parts list

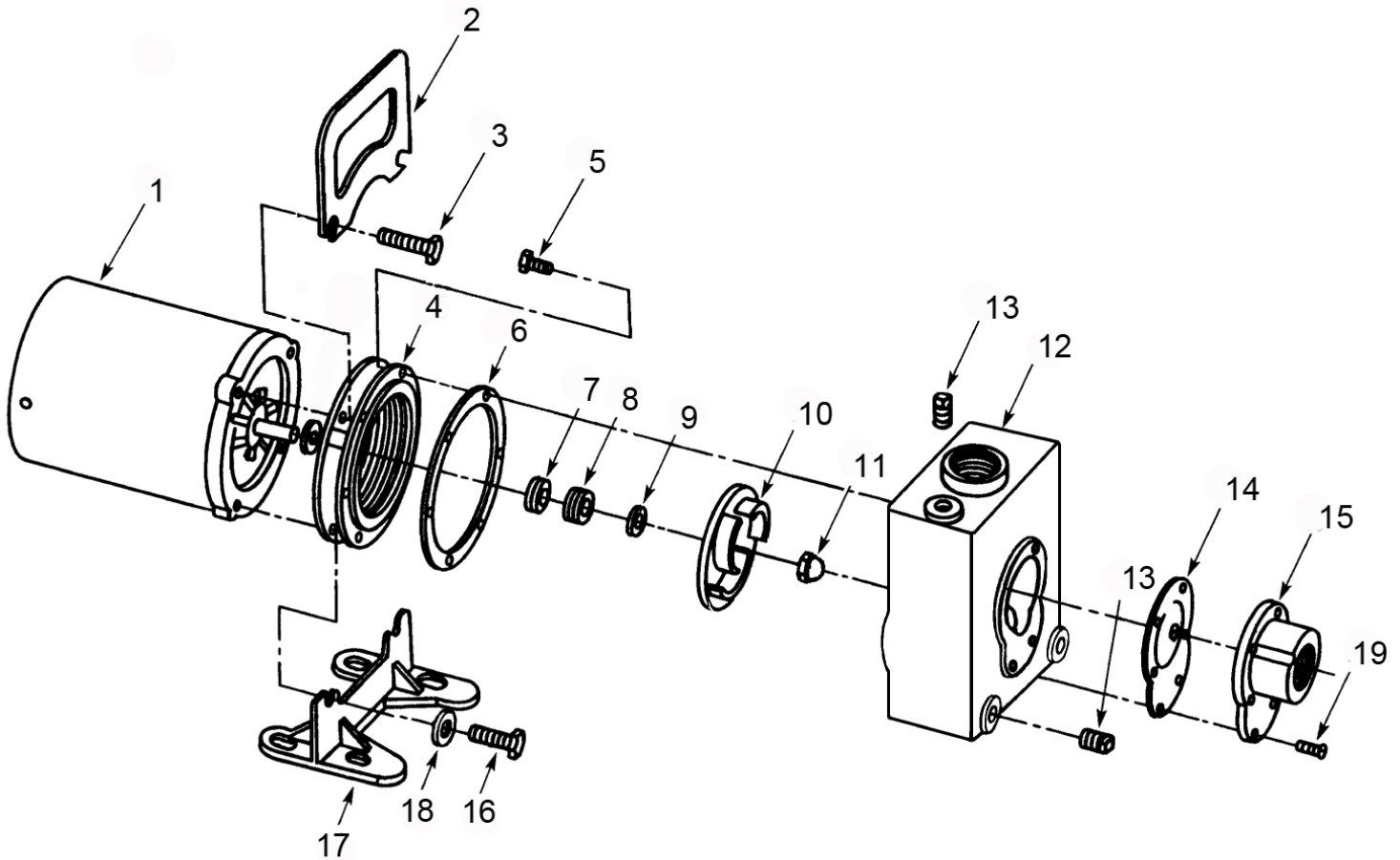

Figure 1 - Repair Parts Illustrations

Repair Parts List

Ref. No.	Description	Part Number for Models				Qty
		2827-95 (1/2HP) 282J-95 (1/2HP) 282D-95 (3/4HP)	2825-95 (3/4HP) 2826-95 (3/4HP) 282C-95 (1HP)	2821-95 (1-1/2HP) 2822-95 (1-1/2HP) 282A-95 (2HP)	2828-95 (2HP) 282L-95 (2HP) 282E-95 (3HP)	
		282F-95 (3/4HP)	282K-95 (1HP)	282B-95 (2HP)	282M-95 (3HP)	
1	Motor - 1 Phase ODP	1626-009-00	1626-010-00	1626-012-00	1626-024-00	1
	Motor - 3 Phase ODP	1626-013-00	1626-014-00	1626-016-00	1626-025-00	1
	Motor - 1 Phase TEFC	1626-302-00	1626-303-00	1626-305-00	1626-306-00	1
	Motor - 3 Phase TEFC	1626-308-00	1626-309-00	1626-311-00	1626-312-00	1
2	Handle	1515-000-00	1515-000-00	1515-000-00	1515-000-00	1
3	Fastener	Incl. w/Ref 4	Incl. w/Ref 4	Incl. w/Ref 4	Incl. w/Ref 4	2
4	Adapter Kit	2820-030-95	2820-030-95	2820-030-95	2820-030-95	1
	(includes Ref. Nos. 3, 4 and 5)					
5	Fastener	Incl. w/Ref 4	Incl. w/Ref 4	Incl. w/Ref 4	Incl. w/Ref 4	4
6	Casing Seal	Incl. w/Ref KIT	Incl. w/Ref KIT	Incl. w/Ref KIT	Incl. w/Ref KIT	1
7 & 8	Shaft Seal Assembly - Buna-N	1640-161-90 & Incl. w/Ref KIT	1640-161-90 & Incl. w/Ref KIT	1640-161-90 & Incl. w/Ref KIT	1640-161-90 & Incl. w/Ref KIT	1
	Shaft Seal Assembly - Viton	1640-161-91 & Incl. w/Ref KIT	1640-161-91 & Incl. w/Ref KIT	1640-161-91 & Incl. w/Ref KIT	1640-161-91 & Incl. w/Ref KIT	1
9	Impeller Shim Set	1657-000-90	1657-000-90	1657-000-90	1657-000-90	1
10	Impeller - 1 Phase	2820-011-01	2820-011-03	2820-011-05	2820-011-07	1
	Impeller - 3 Phase	2820-011-02	2820-011-04	2820-011-06	2820-011-08	1
11	Impeller Fastener	1784-001-00	1784-001-00	1784-001-00	1784-001-00	1
12	Casing Kit - Buna-N	2820-001-B5	2820-001-B5	2820-001-B5	2820-001-B5	1
	Casing Kit - Viton	2820-001-V5	2820-001-V5	2820-001-V5	2820-001-V5	1
	(includes Ref. Nos. 5, 13, 14 and 15)					
13	Pipe Plug	*	*	*	*	3
14	Flapper Valve Assembly - Buna-N	1674-000-90 & Incl. w/Ref KIT	1674-000-90 & Incl. w/Ref KIT	1674-000-90 & Incl. w/Ref KIT	1674-000-90 & Incl. w/Ref KIT	1
	Flapper Valve Assembly - Viton	1674-000-91 & Incl. w/Ref KIT	1674-000-91 & Incl. w/Ref KIT	1674-000-91 & Incl. w/Ref KIT	1674-000-91 & Incl. w/Ref KIT	1
15	Suction Plate	1501-000-01	1501-000-01	1501-000-01	1501-000-01	1
16	Fastener	*	*	*	*	2
17	Foot	1506-000-00	1506-000-00	1506-000-00	1506-000-00	1
18	Washer	*	*	*	*	2
19	Fastener	*	*	*	*	4
KIT	Seal Kit - Buna-N (standard)	2820-304-95	2820-304-95	2820-304-95	2820-304-95	1
	Seal Kit - Viton (optional)	2820-305-95	2820-305-95	2820-305-95	2820-305-95	1
	(includes Ref. Nos. 6, 7, 8 and 14)					

(*) Standard hardware item, available locally.

Self-Priming Centrifugal Pumps

For Repair Parts contact dealer where pump was purchased.

Please provide following information:

-Model Number

-Serial Number (if any)

Part description and number as shown in parts list

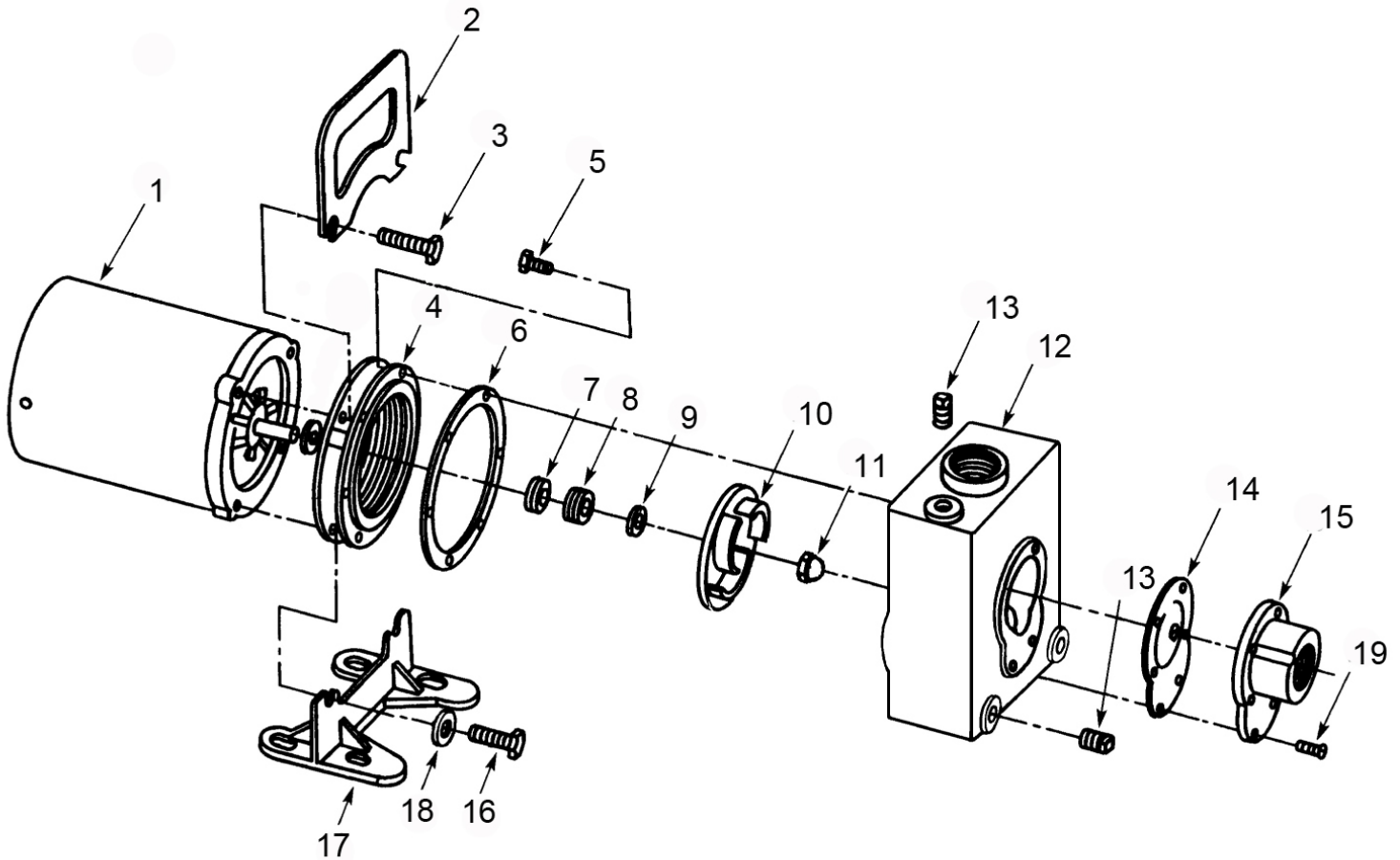

Figure 2 - Repair Parts Illustrations

Repair Parts List

Ref. No.	Description	Part Number for Models			Qty
		2762-95 (1-1/2HP) 2764-95 (1-1/2HP) 276B-95 (2HP) 276D-95 (2HP)	2761-95 (2HP) 2763-95 (2HP) 276A-95 (3HP) 276C-95 (3HP)	2767-95 (3HP) 2766-95 (3HP)	
1	Motor - 1 Phase ODP	1626-012-00	1626-024-00	1626-026-00	1
	Motor - 3 Phase ODP	1626-016-00	1626-025-00	1626-027-00	1
	Motor - 1 Phase TEFC	1626-305-00	1626-306-00	-	1
	Motor - 3 Phase TEFC	1626-311-00	1626-312-00	-	1
2	Handle	1515-000-00	1515-000-00	1515-000-00	1
3	Fastener	Incl. w/Ref 4	Incl. w/Ref 4	Incl. w/Ref 4	2
4	Adapter Kit (includes Ref. Nos. 3, 4 and 5)	2820-030-95	2820-030-95	2820-030-95	1
5	Fastener	Incl. w/Ref 4	Incl. w/Ref 4	Incl. w/Ref 4	4
6	Casing Seal	Incl. w/Ref KIT	Incl. w/Ref KIT	Incl. w/Ref KIT	1
7 & 8	Shaft Seal Assembly - Buna-N	1640-161-90 & Incl. w/Ref KIT	1640-161-90 & Incl. w/Ref KIT	1640-161-90 & Incl. w/Ref KIT	1
	Shaft Seal Assembly - Viton	1640-161-91 & Incl. w/Ref KIT	1640-161-91 & Incl. w/Ref KIT	1640-161-91 & Incl. w/Ref KIT	1
9	Impeller Shim Set	1657-000-90	1657-000-90	1657-000-90	1
10	Impeller - 1 Phase	2820-011-09	2820-011-0B	1496-002-02	1
	Impeller - 3 Phase	2820-011-0A	2820-011-0C	1496-002-02	1
11	Impeller Fastener	1784-001-00	1784-001-00	1784-001-00	1
12	Casing Kit - Buna-N	2760-001-B5	2760-001-B5	2760-001-B5	1
	Casing Kit - Viton (includes Ref. Nos. 5, 13, 14 and 15)	2760-001-V5	2760-001-V5	2760-001-V5	1
13	Pipe Plug	*	*	*	3
14	Flapper Valve Assembly - Buna-N	1683-000-90 & Incl. w/Ref KIT	1683-000-90 & Incl. w/Ref KIT	1683-000-90 & Incl. w/Ref KIT	1
	Flapper Valve Assembly - Viton	1683-000-91 & Incl. w/Ref KIT	1683-000-91 & Incl. w/Ref KIT	1683-000-91 & Incl. w/Ref KIT	1
15	Suction Plate	1487-000-01	1487-000-01	1487-000-01	1
16	Fastener	*	*	*	2
17	Foot	1506-000-00	1506-000-00	1506-000-00	1
18	Washer	*	*	*	2
19	Fastener	*	*	*	4
KIT	Seal Kit - Buna-N (standard)	2760-304-95	2760-304-95	2760-304-95	1
	Seal Kit - Viton (optional) (includes Ref. Nos. 6, 7, 8 and 14)	2760-305-95	2760-305-95	2760-305-95	1

(*) Standard hardware item, available locally.



AMT Pump Company
(herein "AMT")
400 Spring Street
Royersford, PA 19468
Phone: (610) 948-3800
Fax: (610) 948-5300
www.amtpump.com

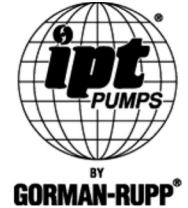

General Information

SALES POLICY: AMT products are sold through our established Distributors. We do not sell direct to the consumer or organization not entitled to trade recognition. Therefore, possession of our catalogs and/or price list(s) does not infer an offer to sell.

MINIMUM ORDER: We appreciate your order, however, all orders are subject to a minimum \$35.00 net invoice charge (excluding freight). This applies to all pump and parts purchase orders.

PRICES: Prices are subject to change without notice. All orders accepted are subject to prices in effect at time of shipment.

PAYMENT TERMS: Terms, upon establishment of credit, are Net 30 days. Past due accounts may be subject to a service charge of 1.5% per month. Domestic or assignable letter of credit is required for all export trade.

PAST DUE ACCOUNTS: AMT reserves the right to withhold open account shipments on any past due account. Invoices are considered past due after thirty (30) days. In the interest of sound business, all orders are subject to approval of the Credit Department.

SHIPPING INSTRUCTIONS: All shipments will be made F.O.B. the factory. Where instructions for shipment do not appear on the order, the shipment will be made according to our best judgment. Full risk of loss (including transportation delays and losses) shall pass to the customer upon delivery of the products to the carrier at the F.O.B. point. When loss or delay occurs, primary responsibility for tracing rests with the customer. When there is LOSS or APPARENT VISIBLE DAMAGE to a shipment, when tendered for delivery, **DO NOT** give the carrier a clear receipt. Note such damage on the carrier's delivery receipt and **HAVE THE DRIVER SIGN THE RECEIPT.**

PRODUCT REVISIONS: AMT reserves the right to discontinue, change or improve its products or any portions thereof without being obligated to provide such a change or improvement for units sold and/or shipped prior to such a change or improvement.

LEAD TIME: Products designated "Quick Ship Product", also referred to as "QSP" will normally be shipped within 24 hours of receipt of a non-cancellable purchase order. Only limited quantities of "QSP" pumps are available.

STANDARD LEAD TIME: Lead time is two weeks for all non "QSP" product. AMT reserves the right to revise lead times as required due to availability of materials and all other causes beyond our control.

VIP SHIPMENT: Select AMT and IPT branded pumps are available for next day shipment for non-QSP (Quick Ship Products) items and subjected to a specific model surcharge per unit noted in the respective price book. Requires calling for availability, confirmation and a non-cancellable purchase order or credit card payment prior to shipment. The expedited shipping charges are an additional cost added separately from the VIP charges per item. AMT reserves the right to revise lead times as required due to availability of materials and all other causes beyond our control. QSP quantities are limited as determined by AMT.

ALL purchase orders must be submitted via hard copy sent to AMT customer service department by fax, EDI or e-mail.

RETURN GOODS POLICY: Goods shall not be returned without a return goods authorization number (RGA) issued by AMT customer service. The RGA number must be listed on the packing list. Only current model and part numbers with a valid date code may be returned (within one year from date of purchase). **A 20% restocking and packaging charge will apply to all returns. All shipping charges must be pre-paid. No exceptions.**

ORDER CHANGES BY CUSTOMER: Orders in process may not be changed except with written consent and may be subject to special charges.

12 Month Limited Warranty

EXTENT AND DURATION OF LIMITED WARRANTY

Coverage: AMT Pump Company (herein "AMT") or IPT Pumps by Gorman-Rupp (herein "IPT") or Gorman-Rupp Industries Division of The Gorman-Rupp Company, Patterson, or the Gorman-Rupp Company (herein referred to as "G-R Unit") each individually warrants that its products and parts shall be free from defects in material and workmanship for twelve (12) months from the date of purchase by the original end user when installation is made and maintenance is performed in accordance with G-R Unit's recommendations. Wear and tear resulting from use and items normally consumed in use are not covered.

EXCEPTIONS

(A) This Limited Warranty shall not apply to mechanical seals in AMT or IPT pumps and the following products and parts: engines, motors, trade accessories and all other products, components, parts and materials not manufactured by the G-R Units. These items may, however, be covered by the warranties of their respective manufacturers. (B) This warranty does not extend to or apply to any unit which has been repaired or altered at any place other than by a G-R Unit, or by persons not expressly approved by a G-R Unit to make repairs or alterations, nor to any unit the serial number, model number or identification of which has been removed, defaced or altered. (C) This warranty does not extend to any product manufactured by a G-R Unit, which has been subjected to mis-use, neglect, accident, improper installation, or use in violation of instructions furnished by a G-R Unit. (D) Pump Kits: This warranty does not extend to any product sold by a G-R Unit unassembled as a Pump Kit. Pump Kits are warranted against defects in material and workmanship for 60 days from the date of shipment from a G-R Unit. Any Pump Kit parts deemed defective by a G-R Unit will be replaced free of charge within 60 days of shipment. Pump Kits are not returnable for credit.

LIMITATIONS

THE G-R UNITS' SOLE AND EXCLUSIVE WARRANTY WITH RESPECT TO THEIR PRODUCTS AND PARTS IS THIS LIMITED WARRANTY. THIS LIMITED WARRANTY IS IN LIEU OF ALL OTHER EXPRESS AND/OR IMPLIED WARRANTIES, INCLUDING IMPLIED WARRANTIES OF MERCHANTABILITY AND FITNESS FOR PARTICULAR PURPOSE.

EXCLUSIVE REMEDY AND DAMAGES

The sole and exclusive remedy for breach of this Warranty by a G-R Unit and the entire extent of its liability for such breach or for damages arising from the use of the products and parts covered under this Limited Warranty, shall be as follows:

- Repair or Replacement:** If inspection shows that any G-R Unit product or part covered under this Limited Warranty is defective in materials or workmanship, the G-R Unit shall repair or replace the defective or non-conforming product or part without charge, whichever the G-R Unit chooses. You must have properly maintained and used the product or part claimed to be defective in accordance with the maintenance schedule or manual, which comes with the product. No allowance will be made for labor, installation, removal, transportation or other charges incurred by you in connection with such repair or replacement.
- To obtain the above remedy:
 - Immediately notify the G-R Unit upon discovery of the claimed defect in materials or workmanship and provide the serial number or date code of the product and/or part(s) or provide the G-R Unit with the invoice or bill of sale referencing the product by no later than the expiration date of the warranty period.
 - The G-R Unit will advise whether inspection will be necessary and how whether repair or replacement will be made. If inspection by the G-R Unit is necessary, the pump or defective part must be sent freight pre-paid to the G-R Unit. Return shipment will be F.O.B. the G-R Unit's plant.
 - Return Goods Authorization Requirement:** No product will be accepted for return or replacement without the prior written authorization of the G-R Unit. Upon such authorization, and in accordance with instructions from the G-R Unit, the product will be returned to the G-R Unit, shipping charges prepaid by the Buyer.
- Damages:** The G-R Unit's liability for damages for breach of this Limited Warranty shall not exceed the amount of the purchase price of the product or part(s) in respect to which Such damages are claimed. **IN NO EVENT SHALL THE G-R UNITS BE LIABLE FOR INCIDENTAL, CONSEQUENTIAL OR SPECIAL DAMAGES FOR BREACH OF THIS LIMITED WARRANTY.**

Some states do not allow the exclusion or limitation of incidental or consequential damages, so the above limitation or exclusion may not apply to you. This Limited Warranty gives you specific legal rights, and you may also have other rights, which vary from state to state.



A Gorman-Rupp Company



BY
GORMAN-RUPP®

www.amtpump.com